

# Intellistage™

the intelligent staging solution for:



**product demos**  
**trade shows**  
**malls**    **houses of worship**  
**meetings**    **schools**  
**demonstrations**  
**performances**    **bands**  
**events**    **fashion shows**  
**promotional events**  
**hotels**    **special events**



# 2013 Catalog





## HOUSES OF WORSHIP



**It's all about value and convenience...** When it comes to portable stage systems, choral risers, seated risers, catwalks and ramps, Intellistage™ definitely upstages the competition. Consisting of modular, lightweight platforms and collapsible risers, Intellistage™ can be set up in a wide variety of heights and configurations by a single person!

When it's time to break down, you'll find that disassembly and storage is equally convenient. Platforms and risers are so compact that they can easily fit in the trunk of a car! Optional transportation/storage cases and trolleys are also available.

**Expandable and upgradable...**

The good news is that as your needs grow, so can your stage system. Intellistage™ stages are the only stages that are completely modular and customizable. Platforms, risers and other components are available on an individual basis so you can customize your stage system (in different heights, configurations and sizes) to accommodate both small and large events. We also offer a full range of accessories like stage skirts, storage/transportation systems, stage back drops, choral risers, seated risers, guard rails, mobile stage kits, ramps and more. So go on! Feel free to take the Stage! Anywhere you like!



## MEETINGS



## TRADE SHOWS

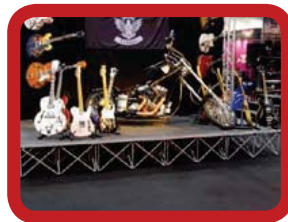

## PRODUCT DEMO'S

## Contents

Introduction	2
Table of Contents	3
Stage Platforms	4
Stage Risers	5
Mobile, Height Adjustable & Waterproof Staging	6
Wheel Chair and Equipment Ramps	7
Stage Guard Rails	8
Stage Back Drops	9
Choral Risers	10
Seated Risers	11
Catwalks, Camera Platforms & Mobile Camera Platforms	12
Drum Risers, Mobile Drum Risers & Performer Packages	13
Prepackaged Stage Kits and Steps	14
Custom Stages & Stage Builder	15
Intellistage™ Online	16
Warranty and Product Manuals	17
Intellistage™ v.s. Other Stages	18
Intellistage™ Applications	19
Storage and Transportation Systems	20,21
Stage Skirts, Hardware and Accessories	22,23

## SPECIAL EVENTS

## FASHION SHOWS

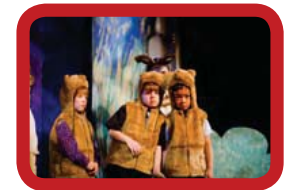
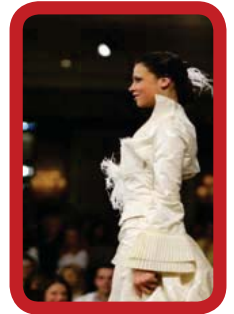

## SCHOOLS



## CONCERTS

## BANDS



# Intellistage stage platforms

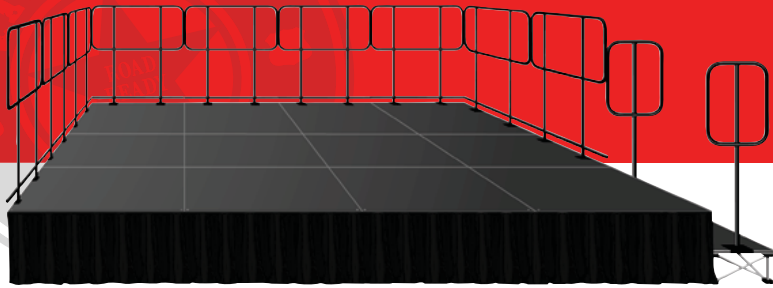

# Intellistage stage risers



## Square Platforms

Available in 3' x 3' or 4' x 4' sizes - in carpet, tuffcoat or industrial finishes. 4' x 4' platforms come standard with cable ports.



## Square Folding Platforms

Available in 3' and 4' sizes - in carpet, tuffcoat or industrial finishes. Folding platforms are perfect for individuals that need to transport stages in the back of their car without taking up a lot of space.



## Triangle Platforms

Isosceles and equilateral triangle platforms are available in 3' and 4' sizes. Available in carpet, tuffcoat or industrial finishes.



## Quarter Round Platforms

Available in 3' and 4' sizes - in carpet, tuffcoat or industrial finishes.



## Step Platforms

Available in 3' x 1' and 4' x 1' sizes - in carpet, tuffcoat or industrial finishes. These platforms are used to create stage steps.

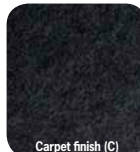

Carpet finish (C)

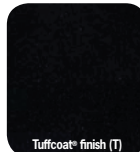

Tuffcoat® finish (T)



Industrial finish (I)

## How Risers and Platforms Work Together to Create Your Dream Stage.

Our unique accordion-style folding stage risers are lightweight, compact and strong. They are rated 185 lbs per sq. ft. Risers lock securely into our stage platforms via special platform locking mechanisms. Stage platforms lock to other platforms using a special hex key and platform to platform connectors built into sides of each platform. Platforms come in various shapes and finishes and risers come in matching shapes and various heights. The result? This unique modular system allows you to create stages in a multitude of heights, shapes and configurations.



## Square Risers

Square Risers are available in 3' x 3' and 4' x 4' sizes and are designed to work with our square platforms and folding platforms. They are available in 8", 16", 24" and 32" heights. Risers can be stacked on top of one another in various height combinations up to 64" high using our optional ISREK riser coupler (never stack more than 2 risers high).



32", 24", 16" and 8" riser heights



## Triangle Risers

Triangle risers are available in 3' x 3' and 4' x 4' sizes and are designed to work with our triangle platforms. They are available in 8", 16", 24" and 32" heights. Risers can be stacked on top of one another in various height combinations up to 64" high using our optional ISREK riser coupler (never stack more than 2 risers high).



## Quarter Round Risers

Quarter round risers are available in 3' x 3' and 4' x 4' sizes and are designed to work with our quarter round platforms. They are available in 8", 16", 24" and 32" heights. Risers can be stacked on top of one another in various height combinations up to 64" high using our optional ISREK riser coupler (never stack more than 2 risers high).



## Step Risers

Step risers are available in a 3' x 1' and 4' x 1' sizes and are designed to work with our step platforms. 3' x 1' risers are available in 8", 16" and 24" heights. 4' x 1' risers are available in 8", 16", 24" and 32" height.

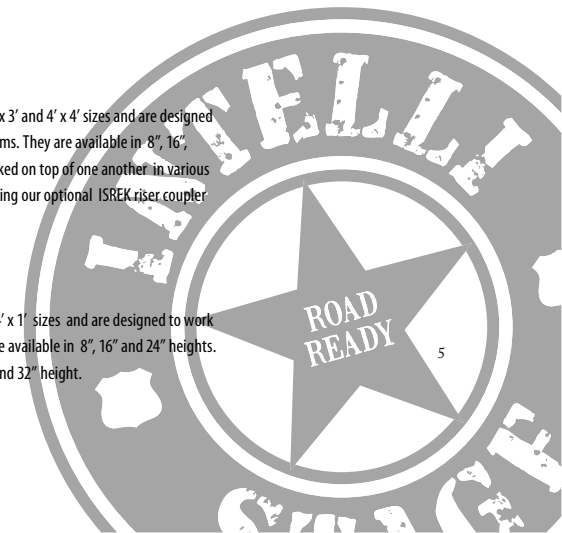

# Mobile, height adjustable, and waterproof stages

# Wheelchair and equipment ramps



## Mobile Stages/Mobile Drum Risers

Any of our stages or drum risers can be made mobile by fitting them with our mobile stage kit. We created metal frames that are designed to fit onto the bottom of our stage risers. Special 3 1/2" wheels with brakes then attach to these frames. The result is a fully mobile stage that can be wheeled from place to place without being disassembled!



## Height Adjustable Stages

Need help setting up your stage on uneven ground? Using the same metal frames that allow you to make our stages mobile, you can easily change out the wheels from the bottom of the frames and replace them with our height adjustable legs. Each leg can be adjusted up to 5" vertically and allows you full and complete control on how you want to set up your stage.



We also offer Riser Leveling Cups to compensate for uneven surfaces. (see page 21) for more info.



## Waterproof Stages

All of our stages (platforms and risers) can be ordered in a waterproof finish. This is a special order item. Please contact your distributor or dealer for more information.

## Wheelchair and Equipment Ramps

Our equipment and wheelchair ramps allow equipment and people easy access to the stage. Easy assembly, compact storage and lightweight, but solid construction are what set Intellistage™ ramps apart. Ramps consist of metal frames and adjustable legs. How do they work? Metal frames and ramp legs are set-up and then the ramp legs are adjusted to create the necessary slope for the ramp. Standard 4' x 4' Intellistage™ platforms (carpet finish, tuff coat finish or industrial finish) are then installed into the metal frames. Intellistage™ ramps offer maximum installation flexibility. Ramps can be attached to Intellistage™ stages straight on, on the side with a landing and in switchback or 90 degree angle configurations for optimal usage of available installation space. Their modular design is also a plus, allowing for easy upgrades when stage heights change.

All wheel chair ramps come standard with guard rails and guard rail options are available for 24" and 32" high equipment ramps. Two different ramp transportation/storage systems are also available. The Trolley system consists of a universal trolley that houses platforms, metal frames and adjustable legs. The Caster Board system consists of a caster board for housing platforms, metal frames and legs.



Trolley and caster transportation/storage systems are available.



find a dealer and more info at [www.Intellistage.com](http://www.Intellistage.com)



Go to [www.Intellistage.com](http://www.Intellistage.com) for detailed assembly instructions on all our products.

# Stage guard rails

# Stage back drops



## Stage Guard Rails

If safety is your concern, our guard rails are the perfect addition to your stage system. Designed to keep performers safe, our guard rails are available in 3 sizes to fit our 4' x 4' platforms, 3' x 3' platforms or our step platforms. All stage platforms come standard with pre-marked holes, so if you decide to add guard rails installation is a snap. Simply drill holes at the pre-marked locations found on the platforms, mount your guard rails with the provided mounting screws and connect the guard rail sections together with our special guardrail to guardrail connector hardware (hardware is included).

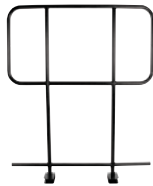

Guard Rail for 4' x 4' Stage Platforms

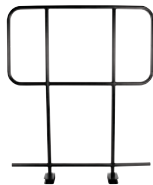

Guard Rail for 3' x 3' Stage Platforms



Guard Rails for Step Platforms



Child Safety Grid

### Guard Rail Covers and Child Safety Grids

Guard Rail Covers and Child Safety Grids are available.



### Guard Rail Transportation System

Holds any combination of 12 guard rails (3' x 3', 4' x 4' or step platform guardrails).

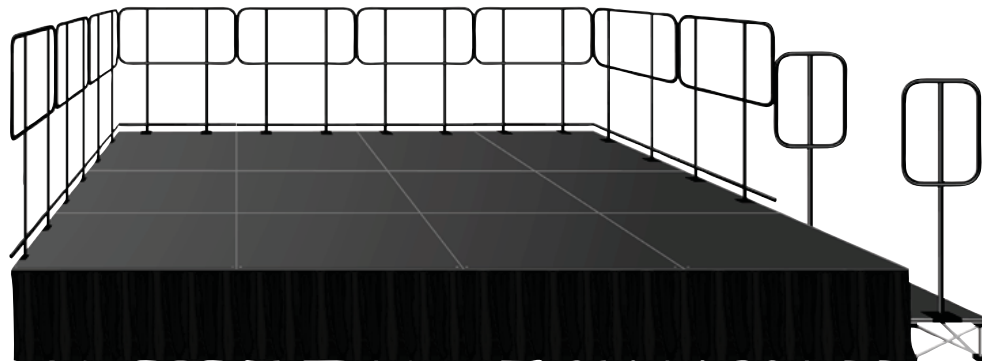

## Stage Back Drops

Intellistage™ back drops provide the perfect finishing touch for your stage system. Designed to work with existing guard rails, our back drops install easily onto our standard Intellistage™ 4' x 4' guard rail panels. Back drops are sold in modular 4 foot sections allowing design flexibility to fit nearly any size stage. One back drop section consists of a 4' wide metal T-bar assembly that installs on top of an existing guard rail. Once installed, the T-bar telescopes out and is adjustable in height from 5' to 12' high depending on your needs. The T-bar's telescope design also allows it to be disassembled and folded down compactly into a 4' high length for easy transportation and storage. Intellistage™ back drop panels are designed to be used with Intellistage™ stage curtains. Intellistage™ stage curtains are available in 8' x 4' wide panels and are made of a black fire retardant material. Intellistage™ stage back drops also allow for easy installation of customers' own custom made curtains, custom banners or projection screens. Storage/transportation bags for back drops and curtains are also available.



Back Drop Frame



Back Drop Frame with Intellistage™ Stage Curtain



Storage/transportation bags are available (bag fits 2 back drops).

find a dealer and more info at [www.Intellistage.com](http://www.Intellistage.com)



## Choral risers

## Seated risers



### Choral Risers

Just like our staging, you can customize our choral risers to fit your needs. Whether you need to hold 12 performers or over a 100 performers, our choral risers are totally modular and can be customized depending on your performance needs. Choral risers are available in 3 tier heights; 8", 16" and 24" and can be set-up on a variety of configurations ( straight, winged or semicircular) and sizes. All systems are available in carpeted, tuffcoat or industrial finishes. Optional guard rails are also available.



10



### Seated Risers

Our seated risers are available in 3 tiered and 4 tiered heights of 8", 16" 24" and 32" and consist of 3' or 4' wide platforms. They are completely modular and customizable and can be set-up to accommodate anywhere from 9 chairs up to over a 100 chairs. The same system can also be set-up in various configurations such as straight, arc shaped, winged and horseshoe shaped configurations; depending on your needs. All systems come standard with chair stops and are available in carpet, tuffcoat or industrial finishes. Optional guard rails are available.



11

find a dealer and more info at [www.Intellistage.com](http://www.Intellistage.com)



# Catwalks and camera platforms

## Catwalks

Our catwalks are 6' wide and consist of square platforms with two matching quarter round platforms to give your catwalk a finished professional look. Catwalks can be used alone or easily attach to the end of your existing stage. They are available in prepackaged kits of different heights and lengths. If you need to add extra length to your catwalk, catwalk extensions are available and are sold in 3' long sections. Skirting options and transportation/storage systems are also available.



6' x 3' Catwalk Extension

## Camera Platforms

Designed to elevate observers, camera operators, or performers to ensure a clear line of sight, our camera platform kits consist of single or double 4' x 4' platforms and matching risers, our camera platform kits are available in 8", 16", 24" or 36" heights and in tuffcoat, industrial or carpeted finishes. Single platforms allow camera and camera men to operate from the same platform, while double platforms allow equipment and camera men to be on two separate platforms thus reducing camera/shake and movement. Mobile camera platforms with wheels are also available. Skirting options and transportation/storage systems are also available.



Mobile camera platforms are also available.



# Drum risers, mobile drum risers and performer packages



## Drum Risers

Finally, the product that everyone has been waiting for. A compact, lightweight, sturdy drum riser. Our drum risers are available in 6' x 6', 8' x 8' and 12' x 8' sizes and are available in 5 different heights; 6", 8", 16", 24" and 32". Small enough to fit in the trunk of your car, these beauties can be used alone or with your Intellistage™ system. Mobile drum risers with wheels are also available. Skirting options and transportation/storage systems are available as well.



Mobile drum risers are also available.



## Performer Packages

For the hard working one man show, we have created several performer packages. They are available in different sizes and heights (choices vary per market. Please contact your Intellistage™ dealer or distributor). We have various packages available for DJ's, guitar players, keyboard players, magicians and more! Economically priced and small enough to fit in the trunk of a car, these are a great value for the working performer. Skirting options and transportation/storage systems are also available.



Storage/transportation dolly available for all performer packages.



# Prepackaged stage kits and steps

# Custom stages and stage builder



## Prepackaged Stage Kits

We take the hassle out of buying a stage with our prepackaged stage kits. These kits are ready to go and include everything you need to get your show going including platforms, risers, and all the necessary hardware for putting your stage together. You can choose from basic stage kits or deluxe stage kits that include guardrails, skirts and steps. Kits are available in 8", 16", 24" and 32" heights and in 96, 192 or 288 square foot configurations. Step kits are also available. (choices vary per market. Please contact your Intellistage™ dealer or distributor).



Basic Stage Kit

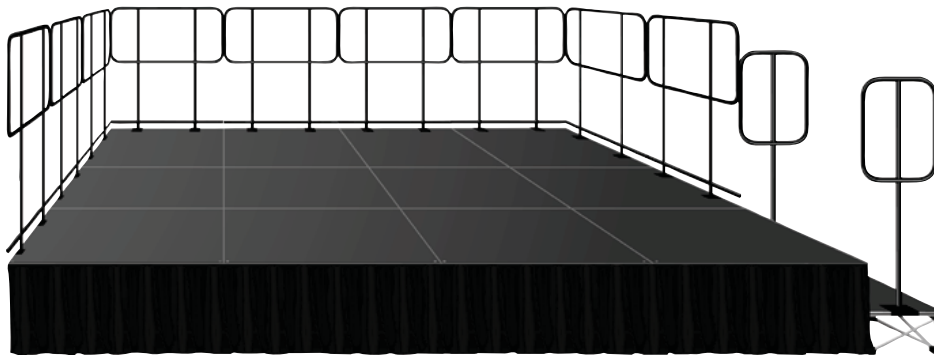

Deluxe Stage Kit

Step Kit



## Create your custom stage online instantly!

To make designing your custom stage a snap, we created our stage builder software. Simply go to [www.intellistage.com](http://www.intellistage.com), click on the stage-builder, and our software will design a custom stage for you according to your specifications. Our software will add anything you need including ramps, guard rails, skirts, transportation/storage systems and accessories and provide you with a detailed design of your new stage as well as a list of all the components that make up your stage. You can then save your custom design as a pdf document.



Go to [www.intellistage.com](http://www.intellistage.com) and build your custom stage today!



**USA**  
 Road Ready Cases USA  
 15662 Central Express  
 Santa Fe Springs, CA 90670  
 Tel: (562) 946-4100 Fax: (562) 946-0100

**INTERNATIONAL:**  
 Available in 120+ other locations an authorized Road Ready distributor in your country and contact them direct by logging onto [www.roadreadycases.com/distributors.php](http://www.roadreadycases.com/distributors.php)



**First name:** John  
**Last name:** Smith  
**Company:** \_\_\_\_\_  
**Address:** 58 Happy Villa Dr.  
**City:** Happyville  
**State:** Ca  
**Zip:** 90000  
**Email:** \_\_\_\_\_  
**Phone:** \_\_\_\_\_

**Stage dimension:** 24' x 40' x 32"

Element code	Element description	Quantity
ISORC	8'x16' ROAD READY ROUNDOFF PLATE	100
ISORPC4	INTELLISTAGE 4' CURVED QUARTER ROUND PLATFORM	4
ISOR4X16	16' HIGH QUARTER ROUND INTELLISTAGE PLATFORM RISER	8
ISPA4X4CD	4' x 4' CURVED QUARTER ROUND INTELLISTAGE PLATFORM RISER	28
IS4X4X16	16' HIGH SQUARE INTELLISTAGE PLATFORM RISER	112
ISSJ	CONNECTING JOIST FOR VARIOUS HEIGHT STAGES & RISES OF PLATE	3
ISSK30X8	8' WIDE X 30' LONG BLACK SKIRT	10
ISSTEP4	4' HIGH CURVED STEP PLATFORM	3
ISSTEP4X8	8' HIGH INTELLISTAGE STEP RISER	1
ISSTEP4X16	16' HIGH INTELLISTAGE STEP RISER	1

The possibilities are endless!

Example of a customer's stage created using the stage builder.







# www.intellistage.com



### Online Intellistage Videos

If you want to see all our products in action and see how easy Intellistage™ is to use, please go to [www.intellistage.com](http://www.intellistage.com). Here you will find short demonstration videos on how our products work so you can see for yourself why Intellistage™ is the intelligent choice.

Demonstration video showing how to assemble your stage.



Video of a car being driven onto one of our stages, illustrating the strength of our staging.



Intellistage.com has all the info you need!

At [www.intellistage.com](http://www.intellistage.com) you will also find detailed info on all our products including product warranty information, owners manuals, a dealer locator and more!

### Intellistage Warranty

Intellistage™ warrants to the original owner of each new Intellistage™ product, for a period of 2 years from the date of purchase, (provided that it is purchased at an Authorized Intellistage™ Dealer) that is free of defects in materials and workmanship and that each product meets or exceeds all factory published specifications. This warranty is void if the product has been tampered with or misused beyond reasonable wear, and shall not apply if the product has been physically damaged. Improper handling, set-up or use of this unit could cause it to fail which could lead to serious injury or death. Please be sure to read, understand and follow all operating instructions and weight load information in manuals before using this product. Do not allow children or untrained persons to use this product. There are no obligations of liability on the part of Intellistage™ for any personal injuries, death, consequential damage or any other indirect damages with respect to, loss of property, revenues, profit or costs of removals, installations or reinstallations arising out of, or in connection with, the use or performance of an Intellistage™ product. \*Only applies to US residents. All others must consult their international distributor.

### Product Manuals

At [www.intellistage.com](http://www.intellistage.com), you will find detailed downloadable product manuals for all our products. Our owner's manuals illustrate clearly how to assemble and disassemble your Intellistage™ products and are full of other useful information regarding your system.

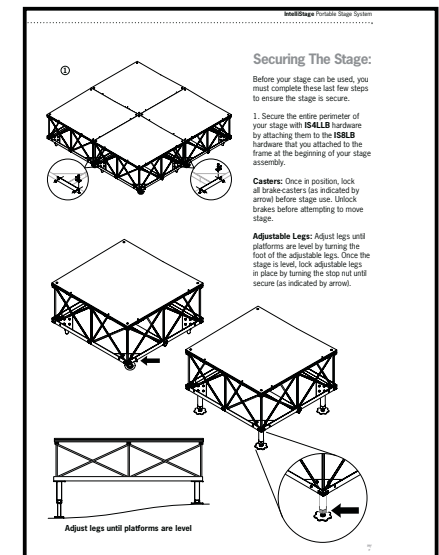
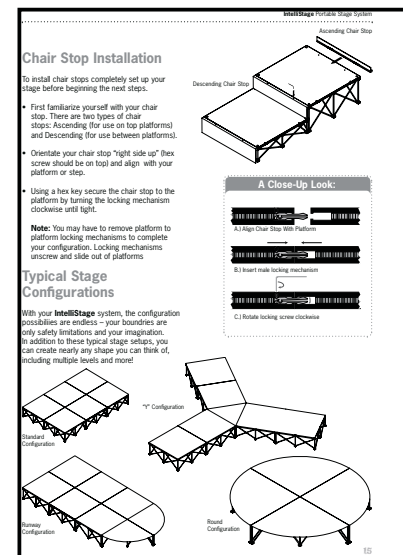

Example of Product Manuals.



## Why is Intellistage the Intelligent Choice?

### Intellistage vs. Other Stages

Fast and easy assembly and disassembly by one person!	Heavy, bulky designs require multiple people to carry, assemble and disassemble the stage.
Smart, modular design allows you to use the same stage for all your needs and change the size, height and shape as you need.  1. Modular square, triangle and quarter round platforms allow you to create any size stage you need and allow you to create shapes such as circles, y-configurations, catwalks or any other shape you may need. We also offer folding square platforms which are ultra easy to store and transport.  2. 8", 16", 24" and 32" risers are available so you can change the height of your stage as needed. You can even stack risers on top of each other (no more than 2 risers high) and create even more height combinations up to the maximum height of 64".	Stages available in large rectangular fixed height platforms. Basically, the stage you buy is the stage you get. If you want to change the size, height or shape you have to buy a whole new stage!  1. These options are just not available.  2. Only fixed heights are available.
4' x 4' stage platforms come standard with cable ports which allow lighting and sound cables to stay out of performers' way.	No cable ports mean sloppy cables and danger for performers.
Easy to upgrade. If you need a bigger stage in the future just purchase more components. They will always work with your existing stage.	The size you buy is the size you get. If you want a new size, height or shape you have to buy a whole new stage.
Light weight, compact design is easy to transport. So compact it can even fit in the trunk of a car for transportation; saving time and money.	Stages usually need to be transported by large trucks or trailers adding to your costs.
Compact storage. Stage platforms can be stacked up and stored in a 4'X4' foot print.  Multiple accessories available such as skirts, chair stops, mobile stage conversion kits, guardrails, equipment and wheel chair ramps, catwalks, adjustable height backdrops, choral risers and seated risers.  1. Mobile Stage Kit: allows you to turn your stage into a mobile wheeled unit.  2. Adjustable height leg kits and riser leveling cups assist with easy set-up on uneven surfaces.  3. Smart equipment and wheel chair ramps can be used in almost any available space and any staging installation. If your needs change, additional components can be purchased to upgrade your ramp so it can be adjusted to use with different height stages.  4. Guard rails work with all platforms and steps.  5. Catwalks are designed to work with existing stage or seperately.  6. Adjustable height back drops.  7. Modular, customizable choral and seated risers are available.	Bulky, large stages usually require warehouse space for storage.  Accessories are limited, not available or must be purchased from another manufacturer.  1. Want a mobile stage? Buy a whole new one with wheels.  2. Need help setting up on uneven surfaces? Use wooden or paper shims and hope for the best.  3. Usually no ramps are available or if they are, they are not adjustable so they cannot fit into tight spaces. Also the same ramp cannot be used with different height stages.  4. Guard rails usually have to be purchased from another manufacturer. They may not fit or match.  5. Catwalks need to be purchased from separate manufacturer.  6. No back drops available or if they are available they are not adjustable.  7. Choral and seated risers are not modular and customizable and need to be purchased from another manufacturer.
Several smart storage and transportation systems available. Pick and choose depending on your needs.  1. ATA storage cases. Perfect for airline travel, rental applications and when you need added security.  2. Caster Board Systems. Perfect for storage and transportation within a venue, school, hotel, church or business  3. Trolleys for storing, platforms, risers, ramps and guardrails.	Storage/transportation systems not available. You need a crew to transport your stage and a warehouse to store it.  1. Not available.  2. Not available.  3. Not available.

## The Possibilities are Endless....

### Sporting Events



### Rental Companies

### Trade Shows



### Event Planners

### DJ's



### Hotels



### Night Clubs

### Fairs



### Movie Events

### Product Displays

### Production Companies And More.....

# Storage and transportation systems

# Storage and transportation systems



## Storage Cases

Perfect for touring or rental applications, our storage cases provide great protection and security for your stage when moving from venue to venue. Mounted on 4 heavy duty casters with brakes, each case fits 6 platforms and 6 risers and even features additional space for hardware, clamps and skirts. Available for 3' x 3' stage systems and 4' x 4' stage systems. 4' x 4' cases feature an easy slide in loading design.



## Stage Platform Transportation Caster System

Capable of holding 24 platforms, our caster boards are designed for on site transportation and storage. Caster boards feature beefy lockable caster wheels, corner locking mechanisms to secure the base platform and industrial straps/ratchets to ensure that nothing moves unless you want it to. The perfect solution for moving an entire stage system for show purposes as well as for storage in between shows. Available for 3' x 3' stage systems and 4' x 4' stage systems.



## Riser/Skirt/Accessory Cases

Our accessory cases are designed to work with our stage platform transportation caster system. Simply strap the accessory case on top of our stage platform transportation caster system and you are ready to roll. These cases are available for 3' x 3' and 4' x 4' stage systems and hold up to 18 risers and skirts. The perfect addition to make organizing and moving your stage even more hassle free!



## Performer Package Storage/Transportation Dolly

Small and compact enough to fit in the trunk of a car, our performer package dolly is designed to work with our performance packages (see page 13). It holds 4 risers and 4 platforms easily and allows the user to wheel them from place to place. Perfect for the hardworking one man performer.



Trolley

## Guard Rail/ Ramp Transportation Systems

We offer two options for guard rail/ramp transportation. Our trolley system consists of a universal trolley that houses either guard rails, or ramp platforms, metal frames and adjustable legs. Our caster board system consists of a caster board for housing ramp platforms, metal frames and legs.



Caster Board



## Storage/Transportation Bags for Stage Back Drops

Designed to store and transport our stage back drops, each bag holds 2 stage back drop frames.



# Stage skirts, hardware and accessories

# Stage skirts, hardware and accessories



## Stage Skirts

When you want to dress-up your stage system a bit, our stage skirts are the perfect solution. They clip onto your stage with special skirt clips. Available in 8" panels, these perfect little black accessories are available in 8", 16", 24" and 32" heights.



## Stage Skirt Clips

Used to attach stage skirts to platforms, our skirt clips are available in a 8 pack and feature Loop & Hook skirt attachments.

ISSKRTCLIPX8 Skirt Clips

## Riser Extension Hardware

Our riser extension hardware allows you to stack any two risers together so you can change the height of your stage to fit your needs (up to 64" high. Do not stack more than 2 risers on top of one another. NOTE: 8" risers can only be placed on the bottom and will not work as the top riser).



ISREK Riser Extension Hardware

## ISRPX4 and ISPTX2 Cable Port Plugs



## Cable Port Plugs

Our 4' x 4' stage platforms come standard with cable ports. We offer cable port plugs in tuffcoat, industrial and carpeted finishes.



IS6LEGX10 Drum Riser Legs

## Drum Riser Legs

10 pack of screw-in 6" high drum riser legs. For use with our drum risers. Drum riser legs are only compatible with 3' x 3' platforms (see page 13).

## Chair Stops

We offer ascending and descending chairs stops for our 3' x 3' and 4' x 4' stage platforms as well as our step platforms.



ISRK Stage Hardware

## Extra Stage Hardware

Our extra parts kit contains: 4 corner locking posts, 4 coupling posts, 4 riser feet, 16 riser pins, 4 hex keys and 4 platform to platform locking mechanisms.



ISSTCUP Leveling Cups



## Riser Leveling Cups

Designed to help compensate for uneven ground, these stacking cups fit on the bottom side of riser feet and snap together with other stacking cups in order to allow you to level out your stage. Available in packs of 25, stacking cups are the fastest way to get your stage level so the show can go on!



IS10RF Rubber Feet

## Rubber Riser Feet

These rubber feet provide added traction on slippery surfaces to ensure your stage stays put.

Available in a 10 pack, they feature self adhesive rubber feet. Simply peel off the adhesive backing and place these rubber feet on the bottom of your existing risers.



ISSJ Connecting Hardware

## Connecting Hardware for Platforms and Steps

Connecting hardware to connect various heights of platforms and steps. Available in a 4 pack.

